

## High Speed Infrared Emitting Diodes, 890 nm, GaAlAs, DH

VSMF2890RGX01



VSMF2890GX01



### DESCRIPTION

VSMF2890RG(G)X01 series are infrared, 890 nm emitting diodes in GaAlAs (DH) technology with high radiant power and high speed, molded in clear, untinted plastic packages (with lens) for surface mounting (SMD).

### FEATURES

- Package type: surface mount
- Package form: GW, RGW
- Dimensions (L x W x H in mm): 2.3 x 2.3 x 2.8
- AEC-Q101 qualified
- Peak wavelength:  $\lambda_p = 890$  nm
- High reliability
- High radiant power
- High radiant intensity
- Angle of half intensity:  $\phi = \pm 12^\circ$
- Low forward voltage
- Suitable for high pulse current operation
- Terminal configurations: gullwing or reserve gullwing
- Package matches with detector VEMD2000X01 series
- Floor life: 4 weeks, MSL 2a, acc. J-STD-020
- Compliant to RoHS Directive 2002/95/EC and in accordance to WEEE 2002/96/EC

AUTOMOTIVE GRADE



RoHS COMPLIANT  
GREEN [5-2008]\*\*

### APPLICATIONS

- IrDA compatible data transmission
- 3D TV
- Miniature light barrier
- Photointerrupters
- Optical switch
- Shaft encoders
- IR emitter source for proximity applications

| PRODUCT SUMMARY |               |              |                  |            |
|-----------------|---------------|--------------|------------------|------------|
| COMPONENT       | $I_e$ (mW/sr) | $\phi$ (deg) | $\lambda_p$ (nm) | $t_r$ (ns) |
| VSMF2890RGX01   | 40            | $\pm 12$     | 890              | 30         |
| VSMF2890GX01    | 40            | $\pm 12$     | 890              | 30         |

#### Note

- Test conditions see table "Basic Characteristics"

| ORDERING INFORMATION |               |                              |                  |
|----------------------|---------------|------------------------------|------------------|
| ORDERING CODE        | PACKAGING     | REMARKS                      | PACKAGE FORM     |
| VSMF2890RGX01        | Tape and reel | MOQ: 6000 pcs, 6000 pcs/reel | Reverse gullwing |
| VSMF2890GX01         | Tape and reel | MOQ: 6000 pcs, 6000 pcs/reel | Gullwing         |

#### Note

- MOQ: minimum order quantity

\*\* Please see document "Vishay Material Category Policy": [www.vishay.com/doc?99902](http://www.vishay.com/doc?99902)

# VSMF2890RGX01, VSMF2890GX01



Vishay Semiconductors High Speed Infrared Emitting Diodes,  
890 nm, GaAlAs, DH

| ABSOLUTE MAXIMUM RATINGS ( $T_{amb} = 25\text{ }^{\circ}\text{C}$ , unless otherwise specified) |  |            |               |                    |
|---|--|------------|---------------|--------------------|
| PARAMETER   | TEST CONDITION                                 | SYMBOL     | VALUE         | UNIT               |
| Reverse voltage   |  | $V_R$      | 5             | V                  |
| Forward current   |  | $I_F$      | 100           | mA                 |
| Peak forward current  | $t_p/T = 0.5$ , $t_p = 100\text{ }\mu\text{s}$ | $I_{FM}$   | 200           | mA                 |
| Surge forward current   | $t_p = 100\text{ }\mu\text{s}$                 | $I_{FSM}$  | 1             | A                  |
| Power dissipation   |  | $P_V$      | 160           | mW                 |
| Junction temperature  |  | $T_j$      | 100           | $^{\circ}\text{C}$ |
| Operating temperature range   |  | $T_{amb}$  | - 40 to + 85  | $^{\circ}\text{C}$ |
| Storage temperature range   |  | $T_{stg}$  | - 40 to + 100 | $^{\circ}\text{C}$ |
| Soldering temperature   | Acc. figure 9, J-STD-020                       | $T_{sd}$   | 260           | $^{\circ}\text{C}$ |
| Thermal resistance junction/ambient   | J-STD-051, leads 7 mm, soldered on PCB         | $R_{thJA}$ | 250           | K/W                |

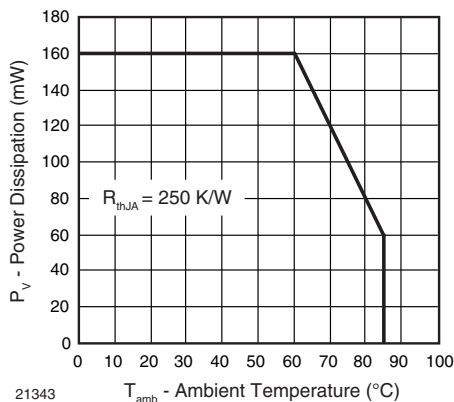

Fig. 1 - Power Dissipation Limit vs. Ambient Temperature

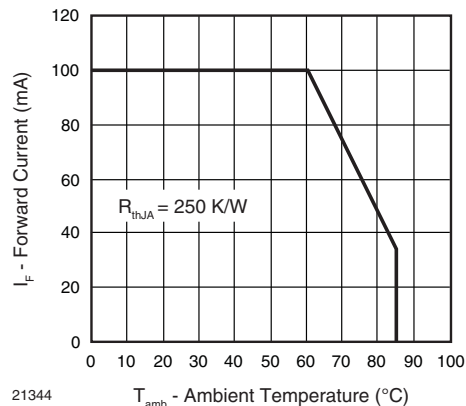

Fig. 2 - Forward Current Limit vs. Ambient Temperature

| BASIC CHARACTERISTICS ( $T_{amb} = 25\text{ }^{\circ}\text{C}$ , unless otherwise specified) |  |                  |      |          |      |               |
|--|--|------------------|------|----------|------|---------------|
| PARAMETER  | TEST CONDITION   | SYMBOL           | MIN. | TYP.     | MAX. | UNIT          |
| Forward voltage  | $I_F = 100\text{ mA}$ , $t_p = 20\text{ ms}$                     | $V_F$            | 1.25 | 1.4      | 1.6  | V             |
|  | $I_F = 1\text{ A}$ , $t_p = 100\text{ }\mu\text{s}$              | $V_F$            |      | 2.3      |      | V             |
| Temperature coefficient of $V_F$   | $I_F = 1\text{ mA}$  | $TK_{V_F}$       |      | - 1.8    |      | mV/K          |
|  | $I_F = 100\text{ mA}$  | $TK_{V_F}$       |      | - 1.1    |      | mV/K          |
| Reverse current  | $V_R = 5\text{ V}$   | $I_R$            |      |          | 10   | $\mu\text{A}$ |
| Junction capacitance   | $V_R = 0\text{ V}$ , $f = 1\text{ MHz}$ , $E = 0\text{ mW/cm}^2$ | $C_J$            |      | 125      |      | pF            |
| Radiant intensity  | $I_F = 100\text{ mA}$ , $t_p = 20\text{ ms}$                     | $I_e$            | 20   | 40       | 60   | mW/sr         |
|  | $I_F = 1\text{ A}$ , $t_p = 100\text{ }\mu\text{s}$              | $I_e$            |      | 350      |      | mW/sr         |
| Radiant power  | $I_F = 100\text{ mA}$ , $t_p = 20\text{ ms}$                     | $\phi_e$         |      | 40       |      | mW            |
| Temperature coefficient of $\phi_e$  | $I_F = 100\text{ mA}$  | $TK_{\phi_e}$    |      | - 0.35   |      | %/K           |
| Angle of half intensity  |  | $\phi$           |      | $\pm 12$ |      | deg           |
| Peak wavelength  | $I_F = 30\text{ mA}$   | $\lambda_p$      | 870  | 890      | 910  | nm            |
| Spectral bandwidth   | $I_F = 30\text{ mA}$   | $\Delta\lambda$  |      | 40       |      | nm            |
| Temperature coefficient of $\lambda_p$   | $I_F = 30\text{ mA}$   | $TK_{\lambda_p}$ |      | 0.25     |      | nm/K          |
| Rise time  | $I_F = 100\text{ mA}$ , 20 % to 80 %                             | $t_r$            |      | 30       |      | ns            |
| Fall time  | $I_F = 100\text{ mA}$ , 20 % to 80 %                             | $t_f$            |      | 30       |      | ns            |
| Cut-off frequency  | $I_{DC} = 70\text{ mA}$ , $I_{AC} = 30\text{ mA pp}$             | $f_c$            |      | 12       |      | MHz           |
| Virtual source diameter  |  | $d$              |      | 1.5      |      | mm            |



# VSMF2890RGX01, VSMF2890GX01

High Speed Infrared Emitting Diodes, Vishay Semiconductors  
890 nm, GaAlAs, DH

## BASIC CHARACTERISTICS ( $T_{amb} = 25\text{ }^{\circ}\text{C}$ , unless otherwise specified)

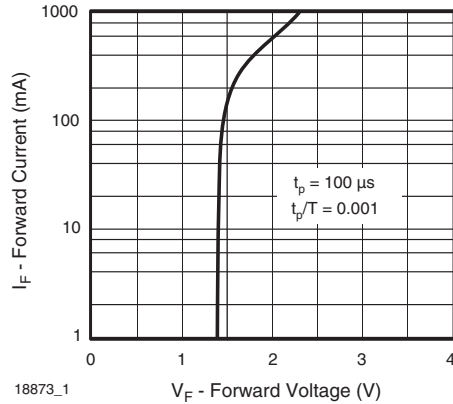

Fig. 3 - Forward Current vs. Forward Voltage

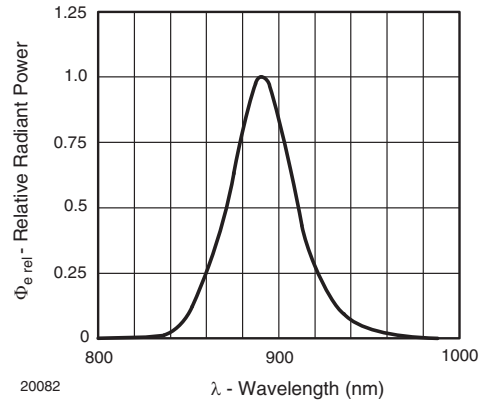

Fig. 6 - Relative Radiant Power vs. Wavelength

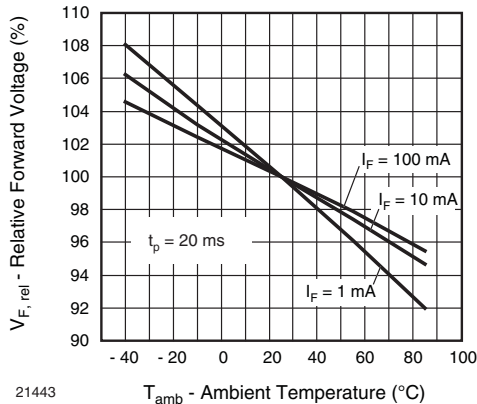

Fig. 4 - Relative Forward Voltage vs. Ambient Temperature

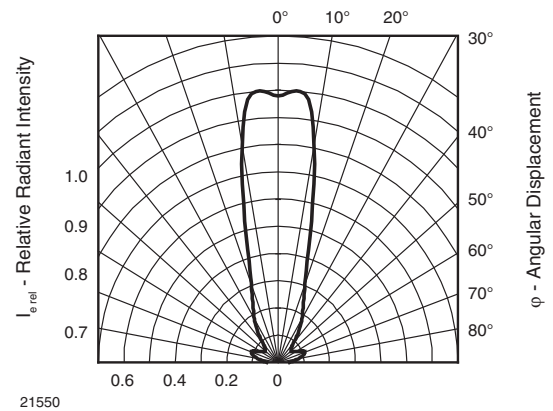

Fig. 7 - Relative Radiant Intensity vs. Angular Displacement

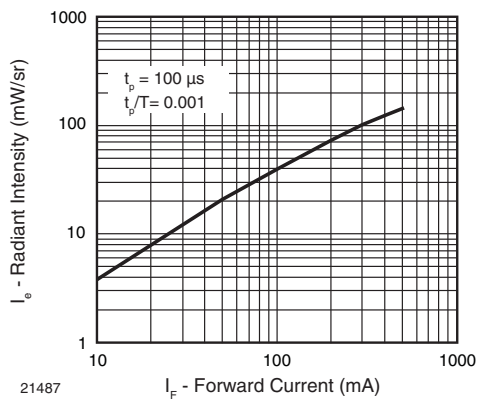

Fig. 5 - Radiant Intensity vs. Forward Current

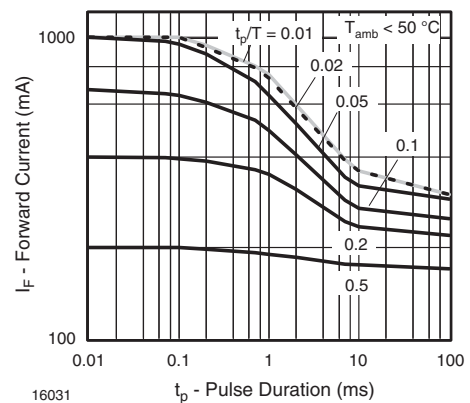

Fig. 8 - Pulse Forward Current vs. Pulse Duration

# VSMF2890RGX01, VSMF2890GX01



Vishay Semiconductors High Speed Infrared Emitting Diodes,  
890 nm, GaAlAs, DH

## SOLDER PROFILE

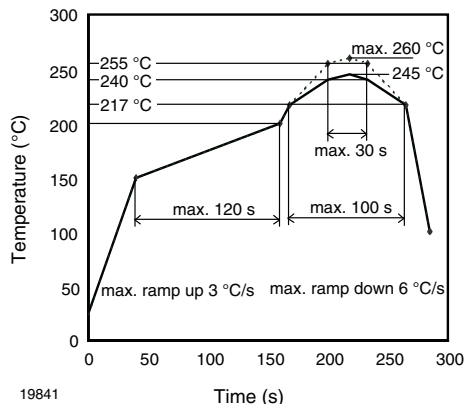

Fig. 9 - Lead (Pb)-free Reflow Solder Profile acc. J-STD-020

## DRYPACK

Devices are packed in moisture barrier bags (MBB) to prevent the products from moisture absorption during transportation and storage. Each bag contains a desiccant.

## FLOOR LIFE

Floor life (time between soldering and removing from MBB) must not exceed the time indicated on MBB label:

Floor life: 4 weeks

Conditions:  $T_{amb} < 30\text{ °C}$ ,  $RH < 60\%$

Moisture sensitivity level 2a, acc. to J-STD-020.

## DRYING

In case of moisture absorption devices should be baked before soldering. Conditions see J-STD-020 or label. Devices taped on reel dry using recommended conditions 192 h at  $40\text{ °C}$  (+  $5\text{ °C}$ ),  $RH < 5\%$ .

## PACKAGE DIMENSIONS in millimeters: VSMF2890RGX01

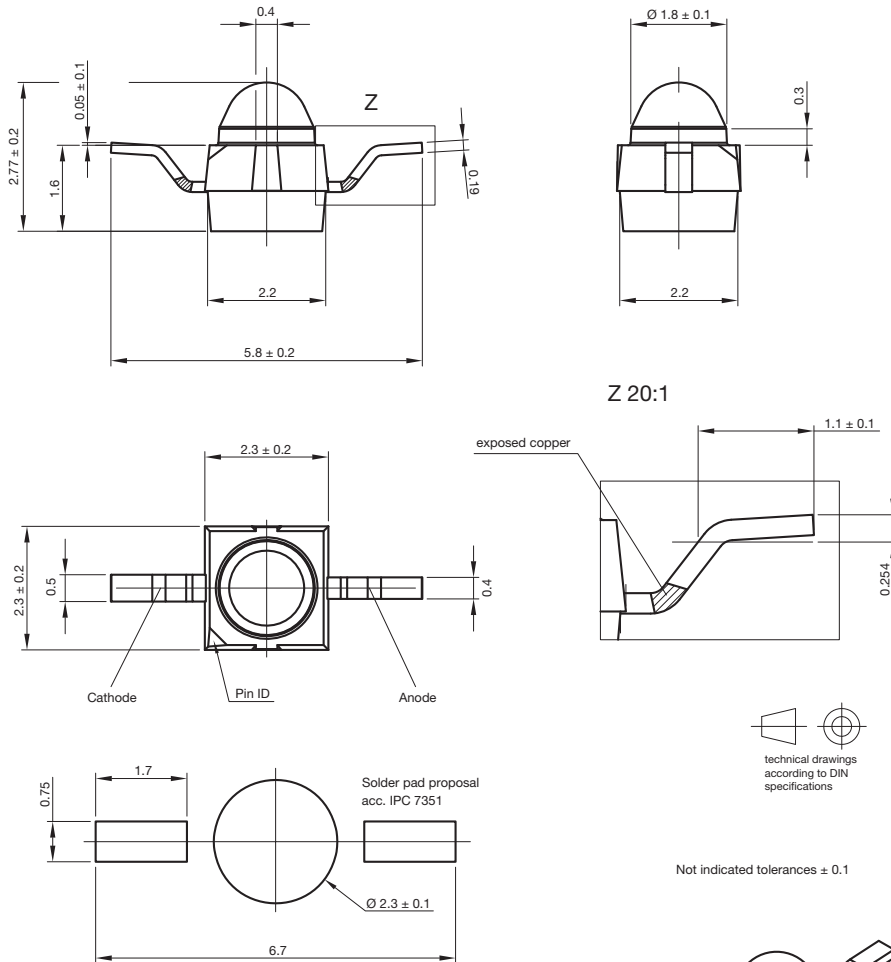

Drawing-No.: 6.544-5391.02-4  
Issue: 2; 18.03.10  
21517

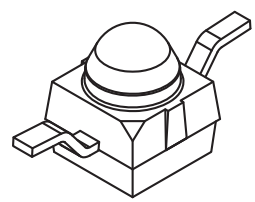



# VSMF2890RGX01, VSMF2890GX01

High Speed Infrared Emitting Diodes, Vishay Semiconductors  
890 nm, GaAlAs, DH

## PACKAGE DIMENSIONS in millimeters: VSMF2890GX01

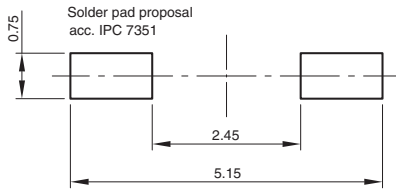
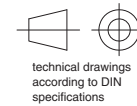
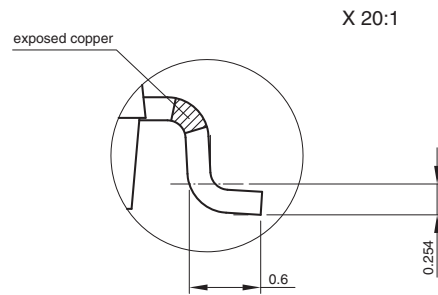
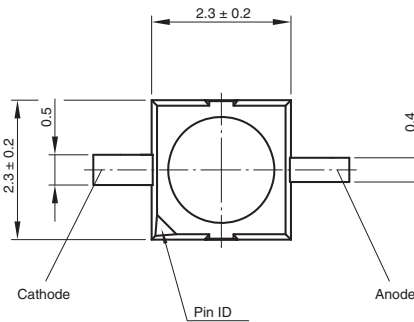
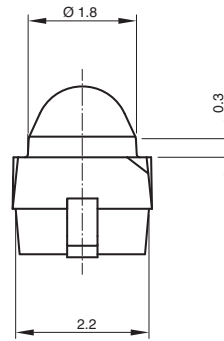
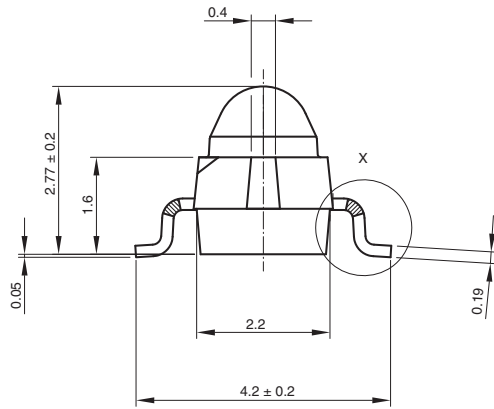

Not indicated tolerances ± 0.1

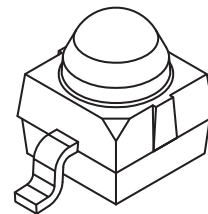

Drawing-No.: 6.544-5383.02-4  
Issue: 4; 18.03.10  
21488

# VSMF2890RGX01, VSMF2890GX01



Vishay Semiconductors High Speed Infrared Emitting Diodes,  
890 nm, GaAlAs, DH

## TAPING AND REEL DIMENSIONS in millimeters: VSMF2890RGX01

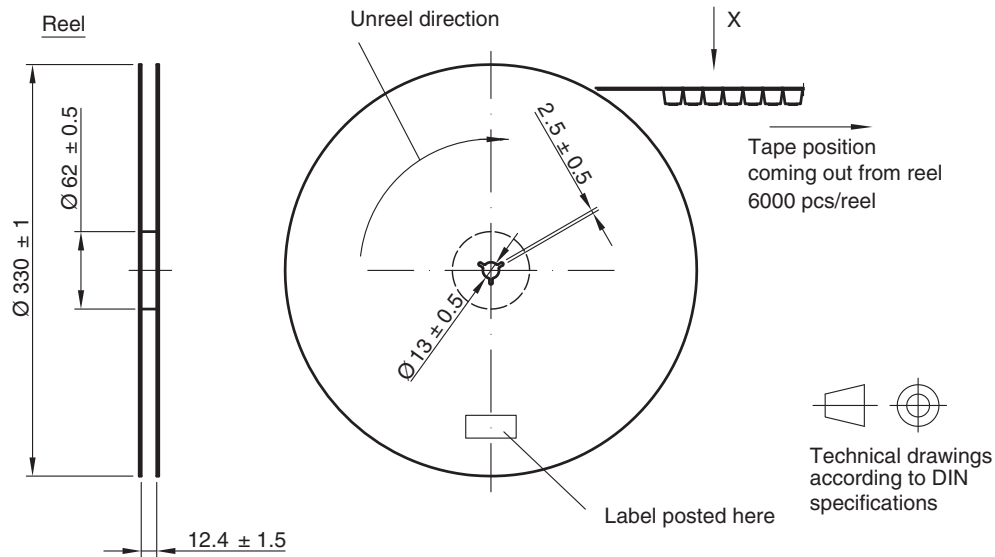

### Leader and trailer tape:

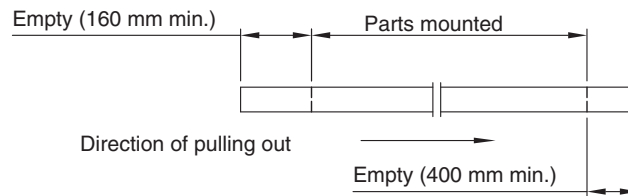

### Terminal position in tape

| Device     | Lead I    | Lead II |
|------------|-----------|---------|
| VEMT2000   | Collector | Emitter |
| VEMT2500   |           |         |
| VEMD2000   | Cathode   | Anode   |
| VEMD2500   |           |         |
| VSMB2000   |           |         |
| VSMG2000   | Anode     | Cathode |
| VSMY2850RG |           |         |

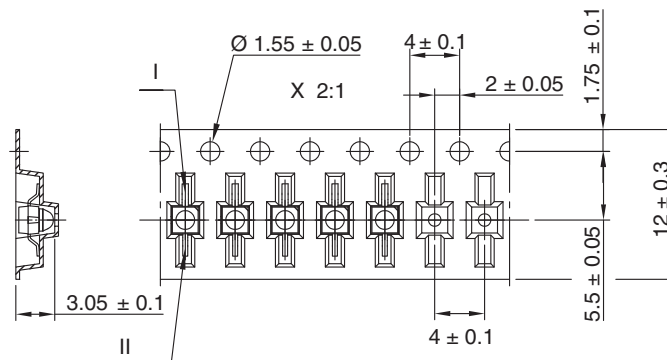

Drawing-No.: 9.800-5100.01-4  
Issue: 2; 18.03.10  
21572



# VSMF2890RGX01, VSMF2890GX01

High Speed Infrared Emitting Diodes, Vishay Semiconductors  
890 nm, GaAlAs, DH

## TAPING AND REEL DIMENSIONS in millimeters: VSMF2890GX01

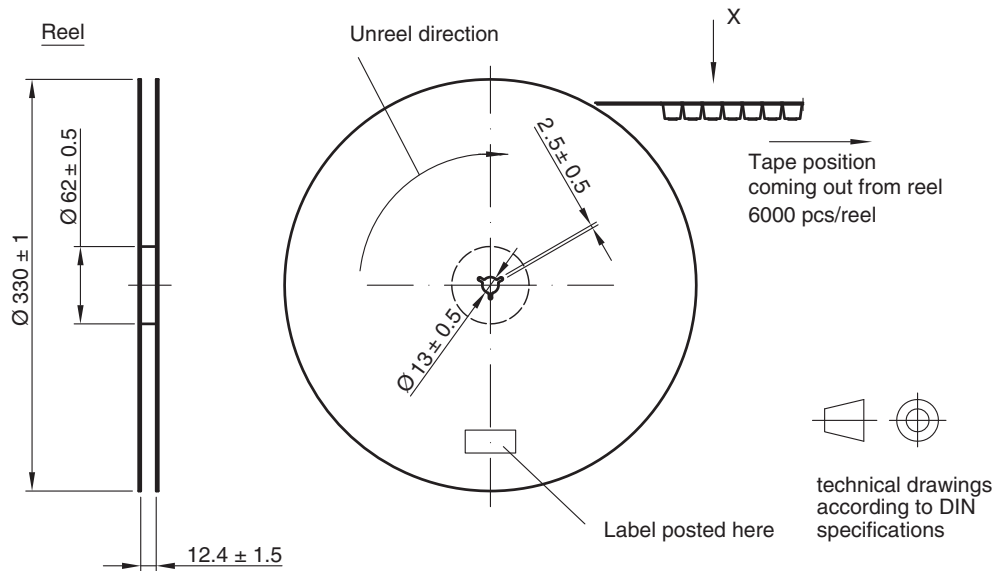

### Leader and trailer tape:

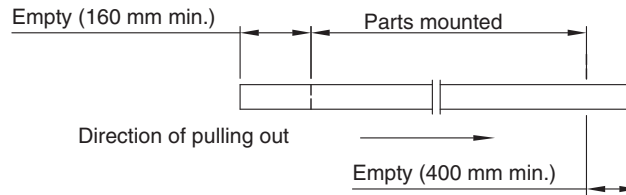

### Terminal position in tape

| Device    | Lead I    | Lead II |
|-----------|-----------|---------|
| VEMT2020  | Collector | Emitter |
| VEMT2520  |           |         |
| VSMB2020  | Cathode   | Anode   |
| VSMG2020  |           |         |
| VEMD2020  |           |         |
| VEMD2520  |           |         |
| VSMY2850G | Anode     | Cathode |

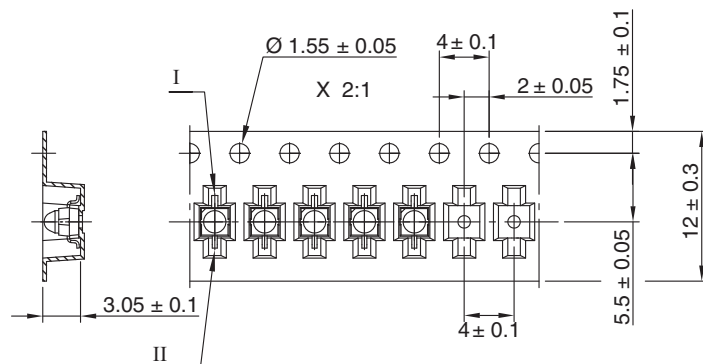

Drawing-No.: 9.800-5091.01-4

Issue: 3; 18.03.10

21571



## Disclaimer

ALL PRODUCT, PRODUCT SPECIFICATIONS AND DATA ARE SUBJECT TO CHANGE WITHOUT NOTICE TO IMPROVE RELIABILITY, FUNCTION OR DESIGN OR OTHERWISE.

Vishay Intertechnology, Inc., its affiliates, agents, and employees, and all persons acting on its or their behalf (collectively, "Vishay"), disclaim any and all liability for any errors, inaccuracies or incompleteness contained in any datasheet or in any other disclosure relating to any product.

Vishay makes no warranty, representation or guarantee regarding the suitability of the products for any particular purpose or the continuing production of any product. To the maximum extent permitted by applicable law, Vishay disclaims (i) any and all liability arising out of the application or use of any product, (ii) any and all liability, including without limitation special, consequential or incidental damages, and (iii) any and all implied warranties, including warranties of fitness for particular purpose, non-infringement and merchantability.

Statements regarding the suitability of products for certain types of applications are based on Vishay's knowledge of typical requirements that are often placed on Vishay products in generic applications. Such statements are not binding statements about the suitability of products for a particular application. It is the customer's responsibility to validate that a particular product with the properties described in the product specification is suitable for use in a particular application. Parameters provided in datasheets and/or specifications may vary in different applications and performance may vary over time. All operating parameters, including typical parameters, must be validated for each customer application by the customer's technical experts. Product specifications do not expand or otherwise modify Vishay's terms and conditions of purchase, including but not limited to the warranty expressed therein.

Except as expressly indicated in writing, Vishay products are not designed for use in medical, life-saving, or life-sustaining applications or for any other application in which the failure of the Vishay product could result in personal injury or death. Customers using or selling Vishay products not expressly indicated for use in such applications do so at their own risk and agree to fully indemnify and hold Vishay and its distributors harmless from and against any and all claims, liabilities, expenses and damages arising or resulting in connection with such use or sale, including attorneys fees, even if such claim alleges that Vishay or its distributor was negligent regarding the design or manufacture of the part. Please contact authorized Vishay personnel to obtain written terms and conditions regarding products designed for such applications.

No license, express or implied, by estoppel or otherwise, to any intellectual property rights is granted by this document or by any conduct of Vishay. Product names and markings noted herein may be trademarks of their respective owners.